

Rückansicht  
M 1/10

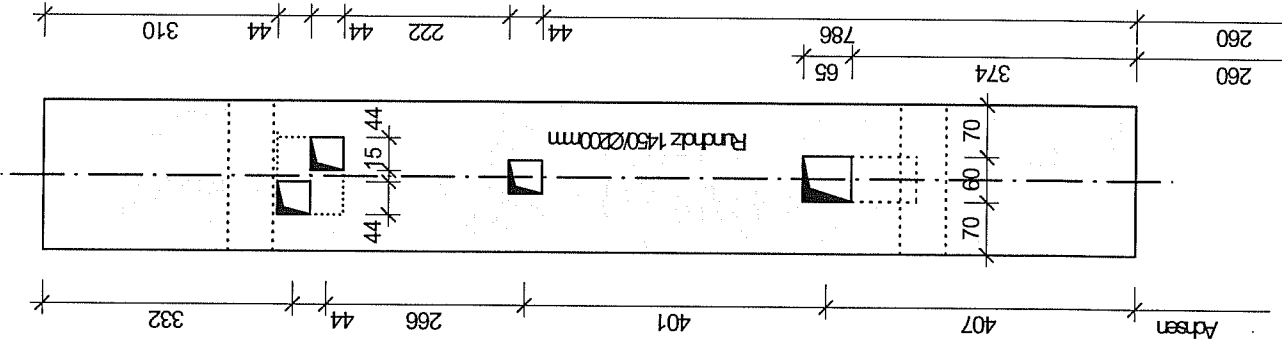

Frontansicht  
M 1/10

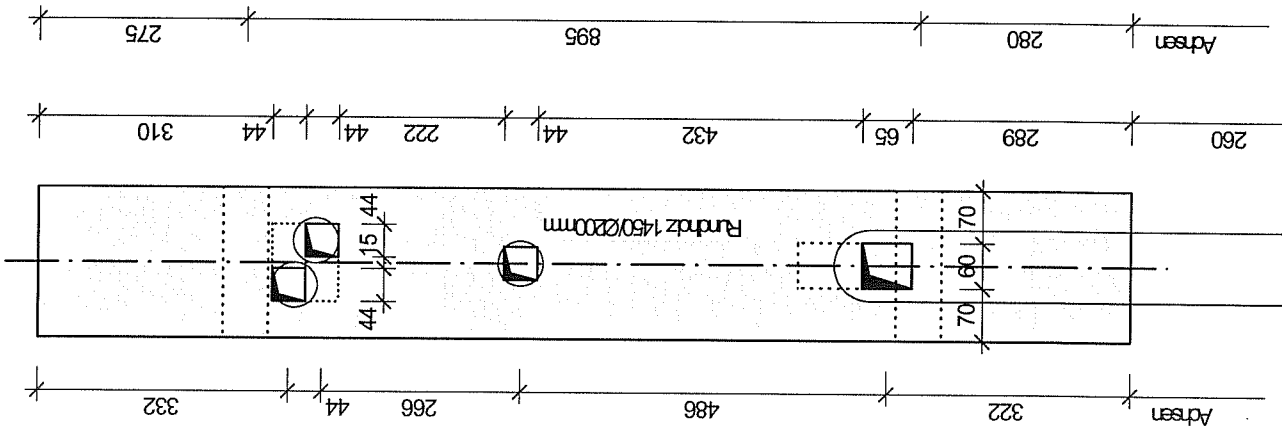

Seitenansicht  
M 1/10

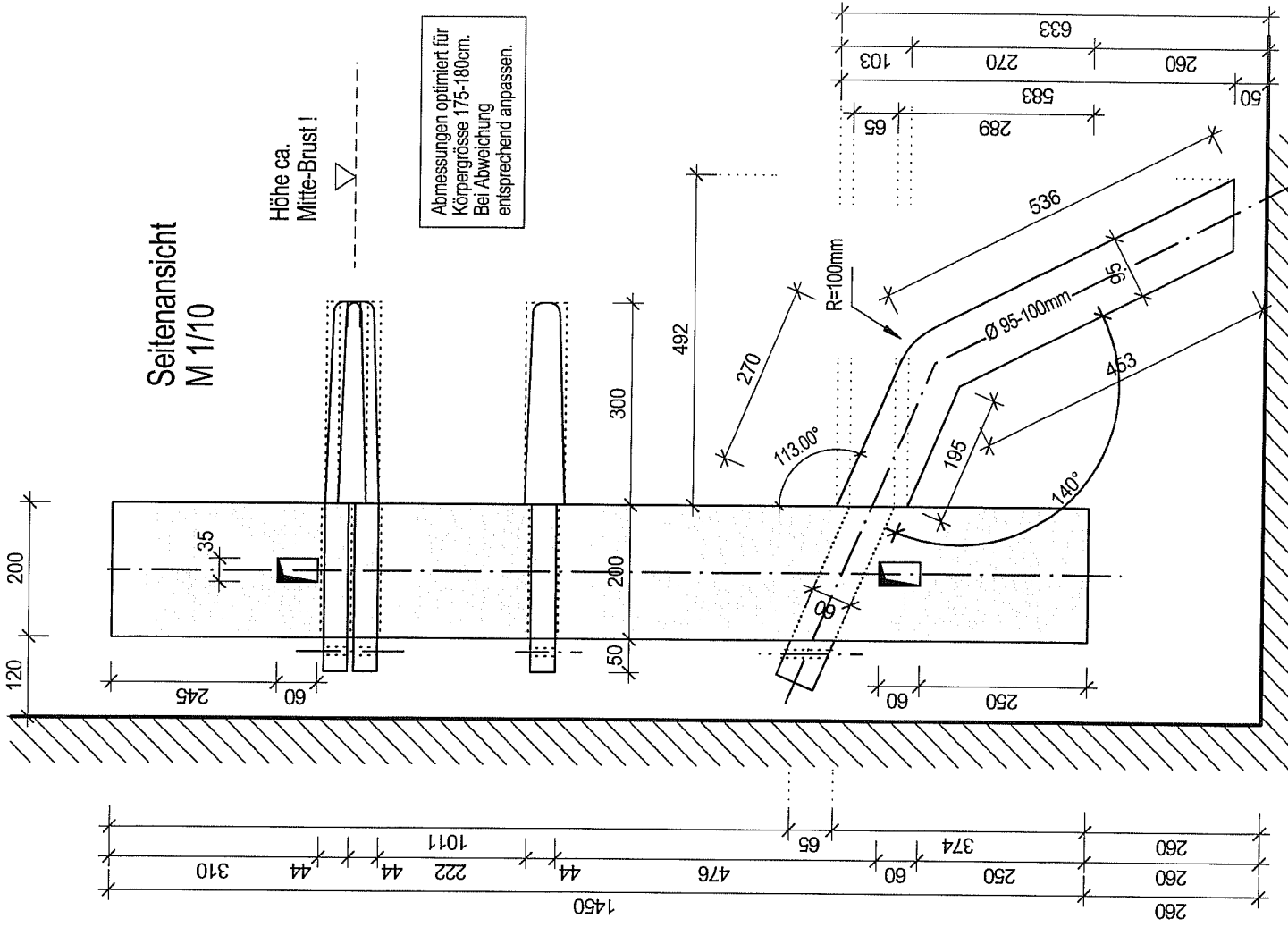

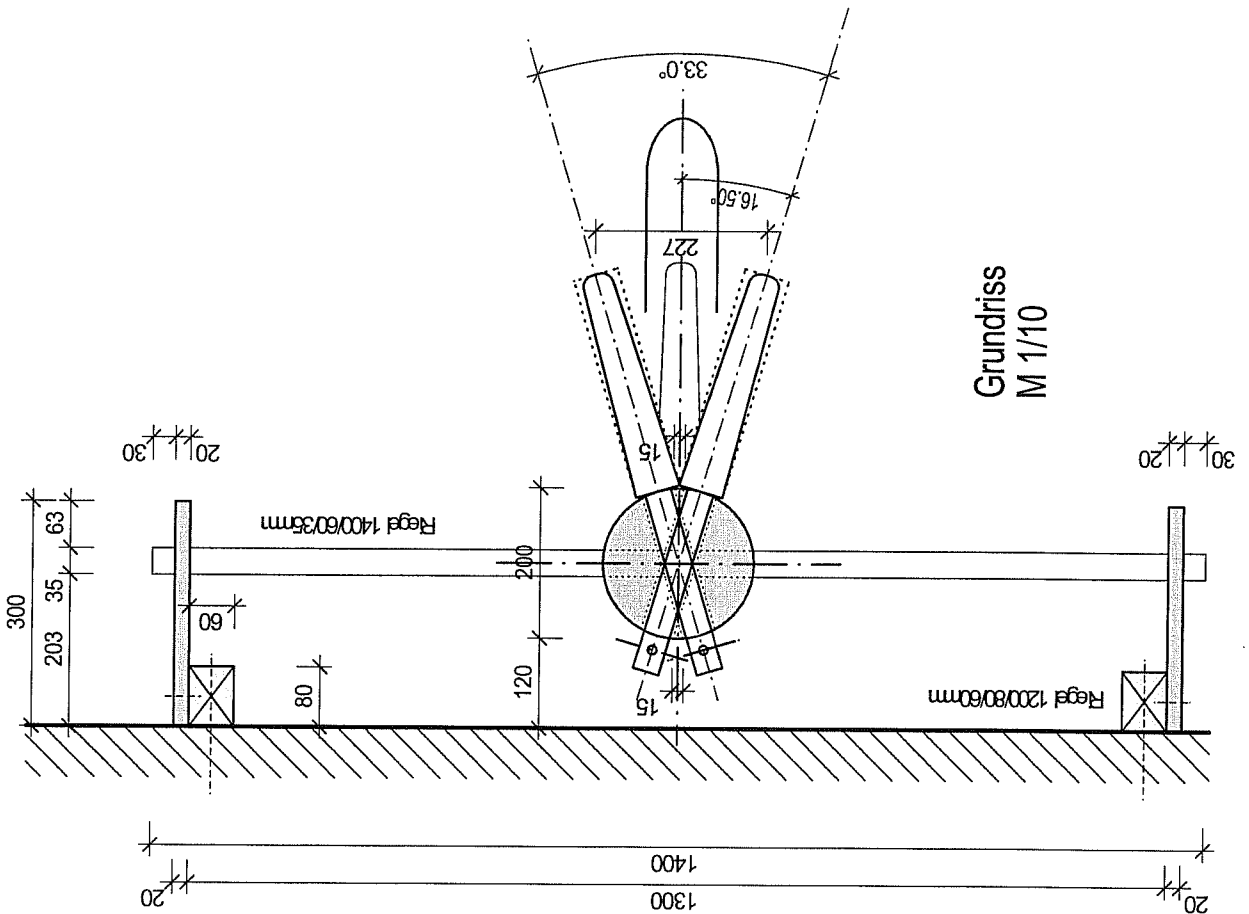
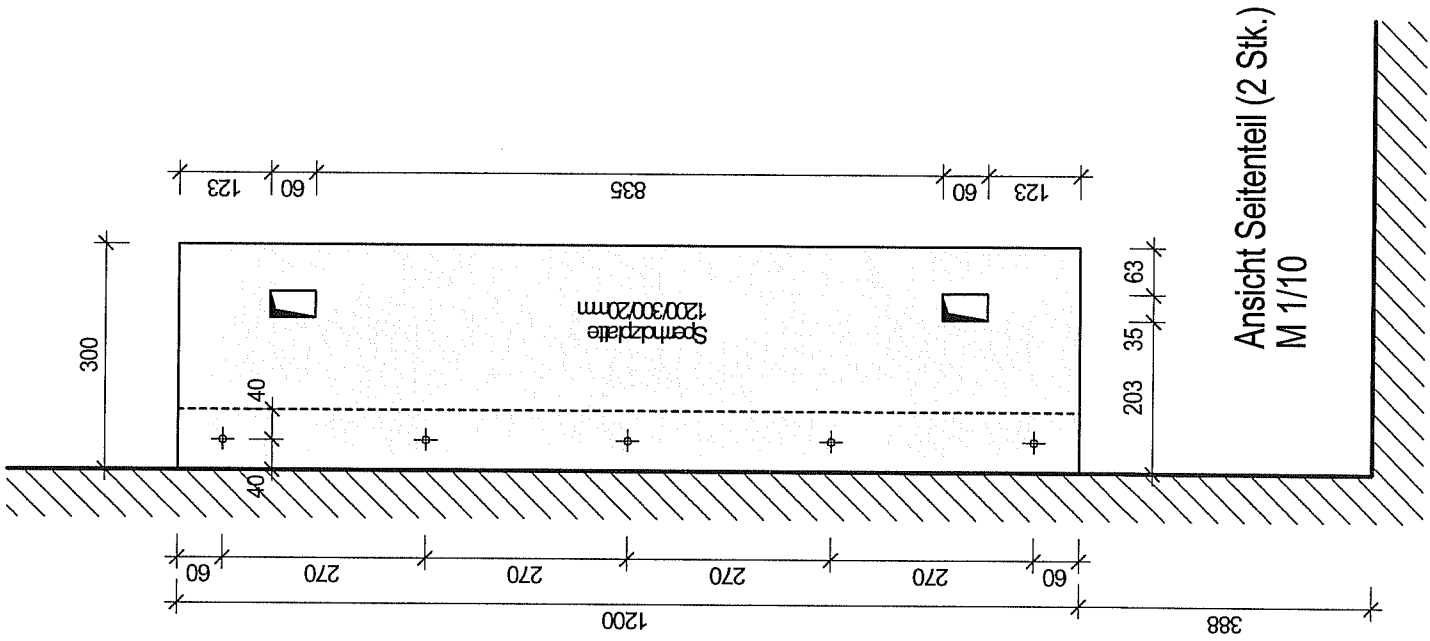

# Arme - oben < 2 Stück pro Puppe >

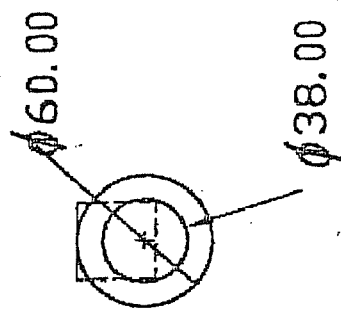

550

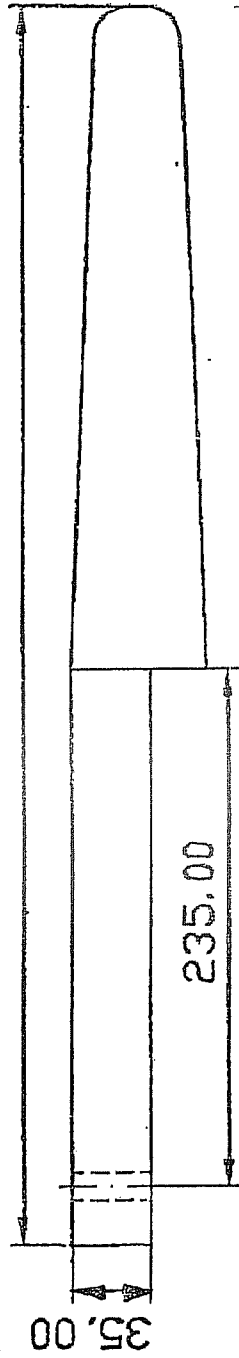

300

250



R = 15mm

$\phi 12.00$

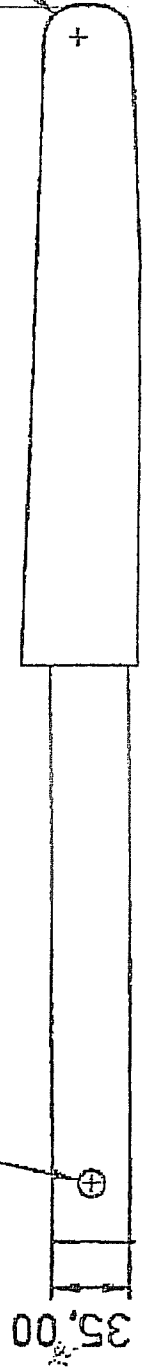

# Arm - unten < 1 Stück pro Puppe >

